

Lorrainedreef

- VI n° de coupe
- 80 n° de compartiment
- Limite de propriété
- - - Limite de coupe
- Limite de compartiment

ZONIËNBOS

XII
120

Chât. du
Long Fond

RO
15

Épur.

Domaine E. Solvay

Tr
Mais
Étg.

42

△ 125

128

14

IV
40

I
10

Montagne
aux Néfliers

94

Chât. de
La Hulpe

Manoir

XII
71

VI
60
FORÊT

V
50

III
30

Chât. de L

70

VIII
80
Sanatorium les Pins

IX
90

Étang
Decellier

LA I

111

XI

DE SOIGNES

100

Jolimont, Chât.





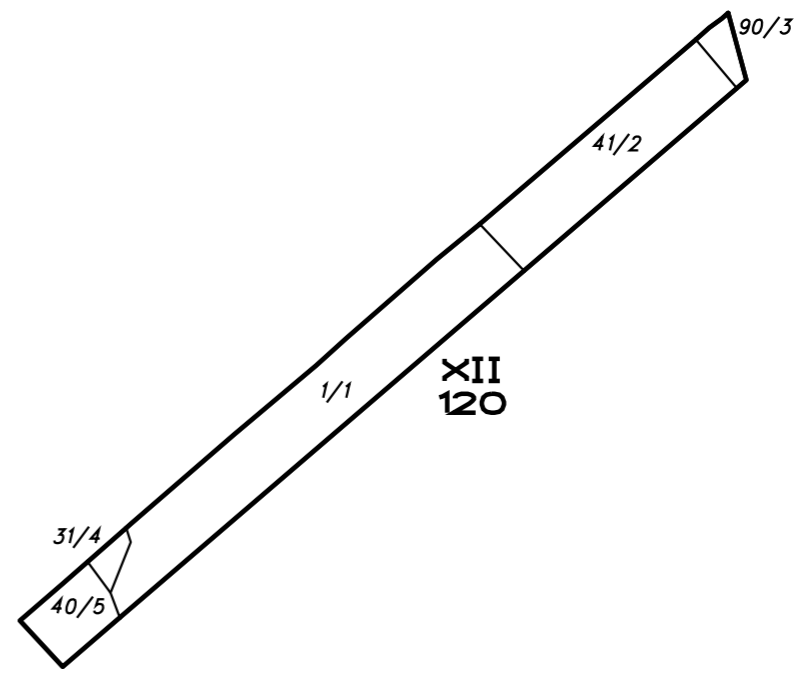
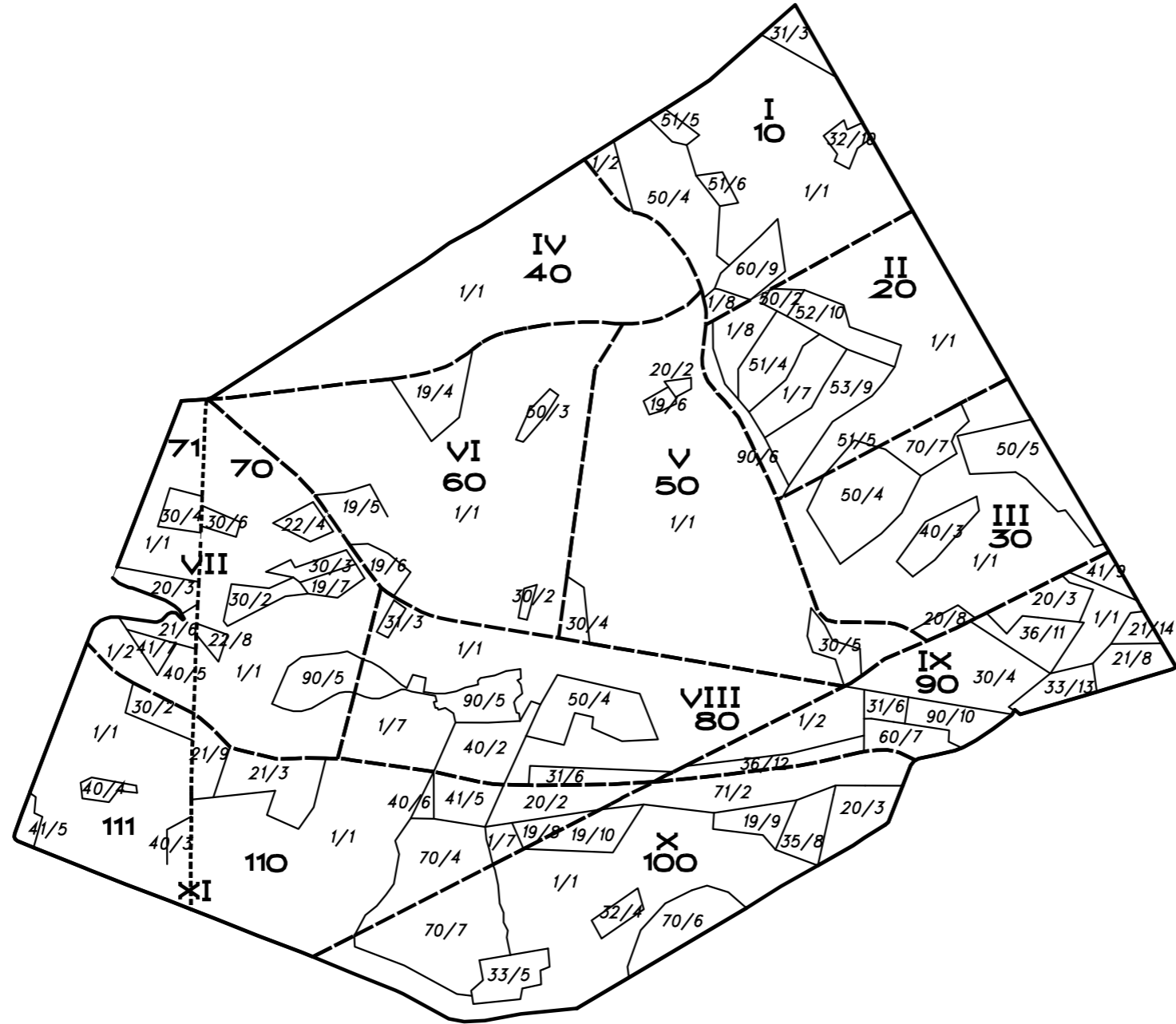

Argentine

Fme La Ramée







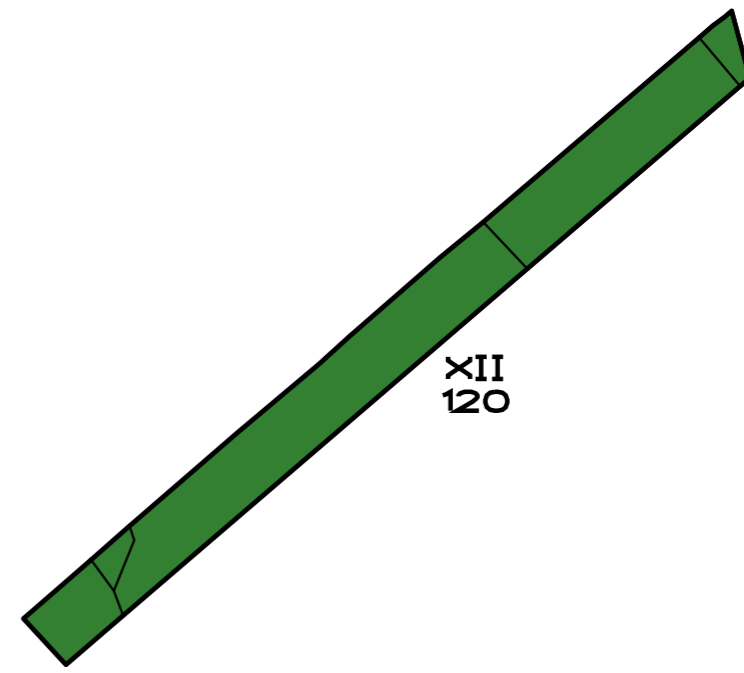
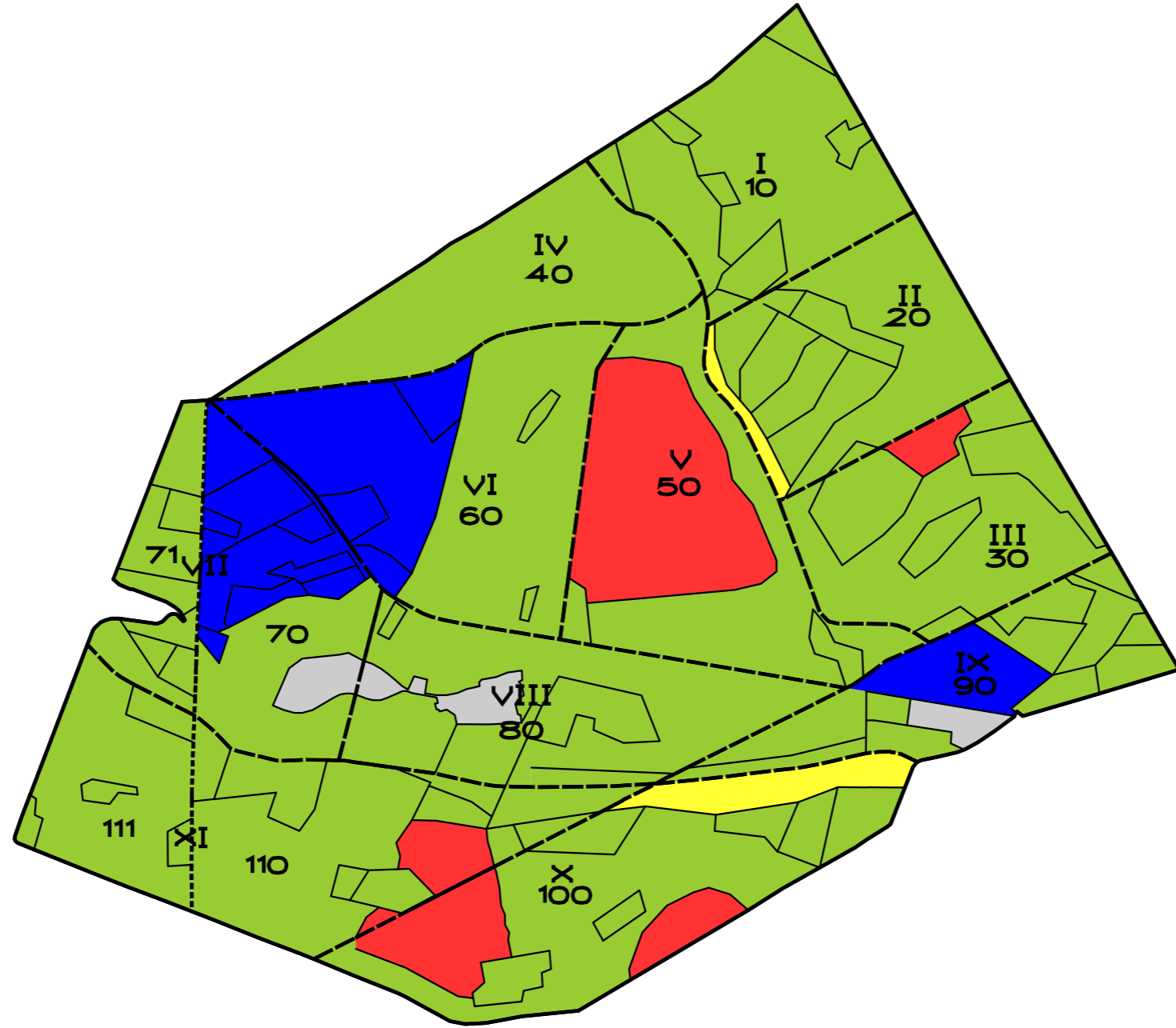

Long

- VI n° de coupe
- 80 n° de compartiment
- 70/3 n° parcelle/ilot
- Limite de propriété
- - - Limite de coupe
- Limite de compartiment
- Limite d'ilot



-  Multifonctionnelle
-  Conservation & production
-  Conservation
-  Intérêt paysager
-  Réserve intégrale
-  Hors cadre



-  *Transfo en futaie irrégulière feuillue*
-  *Transfo en futaie irrégulière mixte*
-  *Restauration futaie irrégulière feuillue*
-  *Entretien futaie régulière (cathédrale)*
-  *Entretien futaie régulière feuillue*
-  *Entretien futaie feuillue irrégulière*
-  *Entretien plage herbeuse*
-  *Laisser-faire forêt feuillue*
-  *Autres*

